

PA 25A and PA 50A wall panels are designed with integrated joint part for rapid assembly, leaving flush surface on both panel sides. Panels are available in modular system. See technical description below.

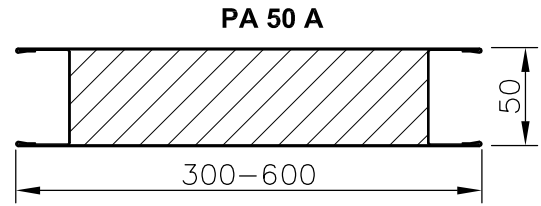

PA 50 AC

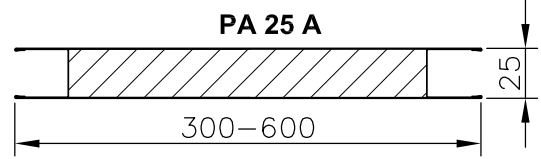
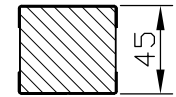

PA 25 AC

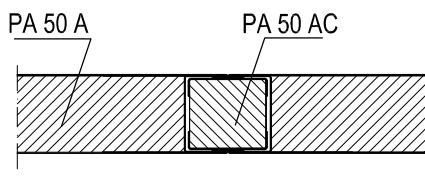
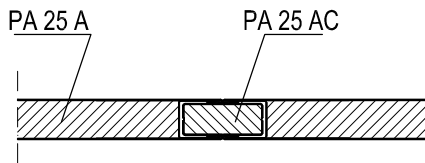
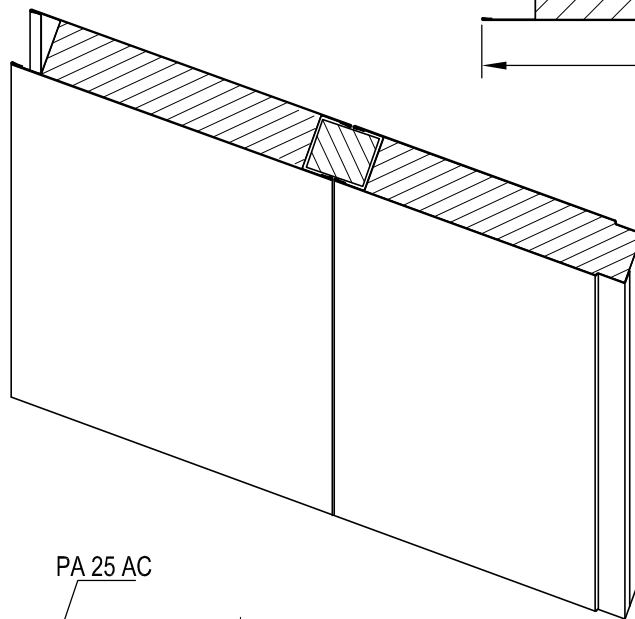
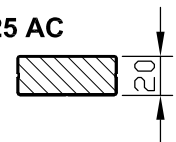

PANEL	PA 25 A	PA 50 A	Core material
Thickness	25 mm	50 mm	Material: mineral wool Density: 150 kg/m ³
Weight	13,8 kg/m	17,5 kg/m ²	
Moduls width	300-600 mm	150-600 mm	Surface material
Moduls length	up to 2500 mm	up to 2500 mm	
Fire class	B-15	B-15	Material: hot dipped galvanised steel sheet Coating: PVC film 150 mm ⁻³ Fire class: low flame spread surface class1
Sound reduction Rw	30 dB	34 dB	
Aplication	lining	partition	

Our products are produced according to our projects and documentation or customer's specification.